

PLASTICS GEARING

REVISED EDITION, JANUARY 1994

William McKinlay and Samuel D. Pierson

Published by:

ABA/PGT PUBLISHING

an affiliate of:

**ABA-PGT Inc.
P.O. BOX 8270
Manchester, Connecticut 06040-0270**

Library of Congress Catalog Card Number: 93-74822

Printed in the United States of America

Copyright 1976 by ABA/PGT Publishing, Manchester, Conn. 06040

INTRODUCTION

PLASTICS GEARING is a reference manual to which industry can turn for technical assistance in plastic gearing and design. It also outlines the services available from its publishers for those who wish to place any phase of design or manufacturing outside.

PLASTICS GEARING is intended to be a continuing publications. Copies are individually numbered and the names of recipients are kept on file. As new material is generated, it will either be forwarded for insertion at no charge or the holder will be advised of its availability and cost.

If this publication does not answer your questions on

■ **GEAR DESIGN**

■ **GEAR MOLDING DIES**

■ **GEAR MOLDING**

call, write, fax or e-mail:

ABA-PGT, Inc.
P.O. Box 8270
Manchester, CT 06040-0270
Phone: (860) 649-4591
Fax: (860) 643-7619
info@abapgt.com
www.abapgt.com

Unless a specific price is quoted for the services requested, there is no obligation on your part.



AN INVITATION TO VISIT US

We would be delighted to show you our facilities and discuss your specific requirements. We believe a visit to our plant will help you resolve a number of questions you may have concerning precision plastics gearing.

Dedicated to the memory of

WILLIAM McKINLAY

a good friend and associate
whose untiring efforts have contributed
significantly to the technology
of plastics gearing

the publishers
August 16, 1976

ACCURATE MOLDED PLASTIC GEARS

CONTENTS

Chapter one	Which are the gear plastics?
Chapter two	What determines which plastic to specify for a given gear?
Chapter three	What properties peculiar to plastics require consideration in the design of a plastic gear?
Chapter four	How should plastic gears be designed? How should their specifications be written?
Chapter five	How accurate are molded plastic gears? What effect does mold shrinkage have on accuracy?
Chapter six	Who are the gear molders?
Chapter seven	How are accurate gear molding dies made?

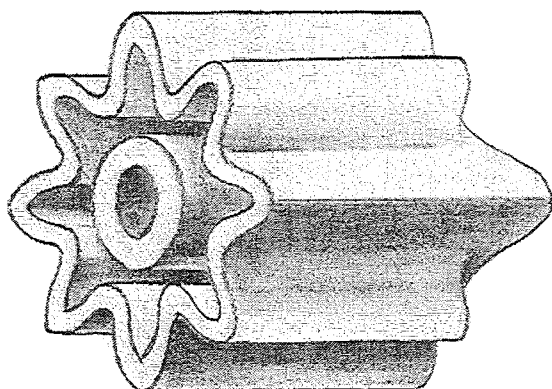

CORED 10 D.P. PINION: ACETAL.

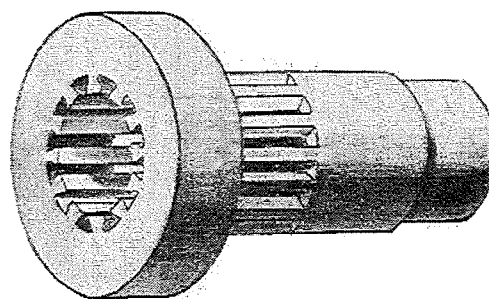

120 D.P. PINION, TEETH SUSPENDED
BETWEEN FLANGES: NYLON

ACKNOWLEDGEMENTS

The authors have drawn freely upon the experience of ABA-PGT inc. in creating a wide variety of gear-molding dies. These dies are molding millions of gears of all types and pitches for use in mechanisms ranging from heavy drives to the most delicate of instruments.

The illustrations throughout the text are of gears similar to those being produced in ABA molding dies for instruments, counting devices, cameras, automotive, appliances, printers, plotters, meters and toys. Artistic liberties have been taken with the illustrations to protect the integrity of proprietary designs.

Reference to published texts are included in the subject matter.

WHAT PLASTICS ARE USED FOR GEARS?

Gears can be molded of many engineering plastics. In spite of the introduction of many new materials, the majority of applications still call for nylons and acetals. In special circumstances, acrylonitrile-butadiene-styrenes (ABS), polycarbonates, polysulfones, phenylene-oxides, polyurethanes, and thermoplastic polyesters can also be considered. All can be obtained in various grades and in filled varieties.

A filled plastic is one to which a material has been added to improve its mechanical properties. The additives normally used in gear plastics are glass, polytetrafluoroethylene (PTFE), silicones, and molybdenum disulphide. Glass is added in the form of short hairlike fibers, miniscule beads, or a fine milled powder. Fibers increase the tensile strength of the molded part just as steel rods reinforce a concrete structure. The presence of fibers, beads or powder causes the part to be more dimensionally stable, but beads or powders do not contribute strength as does fibers. Glass fiber reinforcement can as much as double the tensile strength of a basic material and any type of glass can reduce the thermal expansion of the basic material to as little as one third of the original value.

Carbon fiber is often considered as an additive to increase strength beyond that achievable with glass fibers. It is also claimed to increase wear characteristics. However, these benefits come with some cost. Gear accuracy suffers with the addition of fibers (glass or carbon), there is increased wear on production equipment, and material is more costly. These factors must be considered when designing with carbon filled material.

Molybdenum disulphide, PTFE, PFPE and silicones act as built-in lubricants and make for increased wear resistance. Plastics containing both glass and lubricants are popular for gears.

Selection may be based on financial cost, as well as mechanical or chemical properties. Materials vary not only in basic cost, but in tooling requirements and processing time.

The foregoing merely scratches the surface of the subject of materials. New resins and additives are on the horizon that may offer new options for tomorrow's gear designers. To obtain the most current material data, refer to available sources, such as Modern Plastics Encyclopedia and material suppliers. Data sheets tabulating the mechanical and chemical properties of the plastics and other useful information, can be obtained from them.

WHAT DETERMINES WHICH PLASTIC TO SPECIFY FOR A GIVEN GEAR?

As with any other material, the choice of the plastic is governed by the size and nature of the load to be transmitted, the speed, the life required, the environment in which the gear will operate, the type of lubrication, and the degree of precision necessary.

Because no two gear applications are alike, and because of the wide range of plastics available, it is beyond the scope of this chapter to deal with the subject on any but general terms. The equations that follow, used in conjunction with the accompanying tables, will help to determine which, if any, of the plastics are viable materials in terms of the strength required. The equations are simple variations of the Lewis formula, and assume the use of standard tooth forms. The answers they give are conservative, and should be so regarded; but are of sufficient accuracy to enable a decision to be made whether a further study in depth is warranted. Such a study will involve a requirement that the gear be designed for the specific application under review. How this is accomplished is the subject matter of the sections to follow.

Spur gearing (External and Internal)

$$HP = \frac{S_s F Y V}{55(600 + V) P C_s}$$

Helical Gearing (External and Internal)

$$HP = \frac{S_s F Y V}{423(78 + \sqrt{V}) P_n C_s}$$

Straight Bevel Gearing

$$HP = \frac{S_s F Y V (C - F)}{55(600 + V) P C C_s}$$

- S_s = safe stress. Table 1
- F = face width in inches
- Y = tooth form factor. Table 2
- V = velocity in feet per minute at pitch circle diameter
- P = diametral pitch
- P_n = normal diametral pitch
- C_s = service factor. Table 3
- C = outer cone distance

**WHEN USING
THE PGT BALANCED
TOOTH STRENGTH
SYSTEM, REFER TO
CHAPTER 11 FOR A
MORE ACCURATE
ANALYSIS.**

Table 1 SAFE STRESS

Plastic	Safe Stress	
	Unfilled	Glass-reinforced
ABS	3,000	6,000
Acetal	5,000	7,000
Nylon	6,000	12,000
Polycarbonate	6,000	9,000
Polyester	3,500	8,000
Polyurethane	2,500	

ACCURATE MOLDED PLASTIC GEARS

The figures for safe stress in Table 1 allow for a moderate temperature increase and assume some initial lubrication. The values given to the safe stress of the glass-reinforced plastics should be used with discretion. The glass-reinforced varieties have qualities that make them superior to the unfilled plastics for certain gear applications; but for other applications their greater strengths may be more apparent than real.

Table 2. TOOTH FORM FACTOR Y

Number of Teeth	14½° Involute or Cycloidal	20° Full Depth Involute	20° Stub Tooth Involute	20° Internal Full Depth	
				Pinion	Gear
12	0.210	0.245	0.311	0.327	-
13	0.220	0.261	0.324	0.327	-
14	0.226	0.276	0.339	0.330	-
15	0.236	0.289	0.348	0.330	-
16	0.242	0.295	0.361	0.333	-
17	0.251	0.302	0.367	0.342	-
18	0.261	0.308	0.377	0.349	-
19	0.273	0.314	0.386	0.358	-
20	0.283	0.320	0.393	0.364	-
21	0.289	0.327	0.399	0.371	-
22	0.292	0.330	0.405	0.374	-
24	0.298	0.336	0.415	0.383	-
26	0.307	0.346	0.424	0.393	-
28	0.314	0.352	0.430	0.399	0.691
30	0.320	0.358	0.437	0.405	0.679
34	0.327	0.371	0.446	0.415	0.660
38	0.336	0.383	0.456	0.424	0.644
43	0.346	0.396	0.462	0.430	0.628
50	0.352	0.408	0.474	0.437	0.613
60	0.358	0.421	0.484	0.446	0.597
75	0.364	0.434	0.496	0.452	0.581
100	0.371	0.446	0.506	0.462	0.565
150	0.377	0.459	0.518	0.468	0.550
300	0.383	0.471	0.534	0.478	0.534
Rack	0.390	0.484	0.550	-	-

For bevel gearing, multiply number of teeth in gear by the secant of the pitch angle and use answers in Table 2. For example, if a 20° PA bevel gear has 40 teeth and a pitch angle of 58°, $40 \times \secant 58^\circ = 40 \times 1.88708 = 75$, and $Y = .434$.

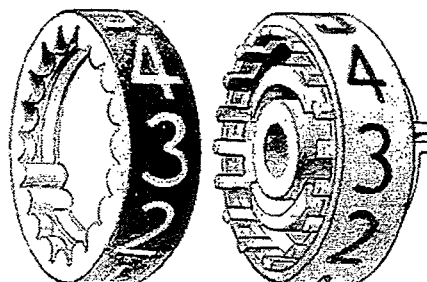

NUMBER DRUMS, 38 D.P. INTERNAL AND EXTERNAL GEARS: ACETAL

ACCURATE MOLDED PLASTIC GEARS

Table 3. SERVICE FACTOR

Type of Load	Type of Service			
	8-10 hours per day	24 hours per day	Intermittent 3 hours per day	Occasional ½ hour per day
Steady	1.00	1.25	0.80	0.50
Light shock	1.25	1.50	1.00	0.80
Medium shock	1.50	1.75	1.25	1.00
Heavy shock	1.75	2.00	1.50	1.25

At this point it might be helpful to work through an example. Assume that it is required to choose a plastic for a spur gear which is to transmit ⅛ HP at 350 R.P.M. The gear will run 8 hours per day and the load is steady. The gear has the following data:

Number of teeth	75
Diametral pitch	32
Pressure angle	20°
Pitch diameter	2.34375
Face width	.375

$$HP = \frac{S_s F Y V}{55(600 + V) P C_s}$$

$$S_s = \frac{55(600 + V) P C_s HP}{F Y V}$$

$P = 32$	$D = 2.34375$
$C_s = 1.0$	$RPM = 350$
$HP = .125$	$Y = .434$
$F = .375$	

$$V = \frac{RPM \times \pi \times D}{12}$$

$$V = \frac{350 \times 3.1415926 \times 2.34375}{12}$$

$$= 215 \text{ f.p.m.}$$

$$S_s = \frac{55(600 + 215) 32 \times 1.00 \times .125}{.375 \times .434 \times 215}$$

$$= 5,124 \text{ P.S.I.}$$

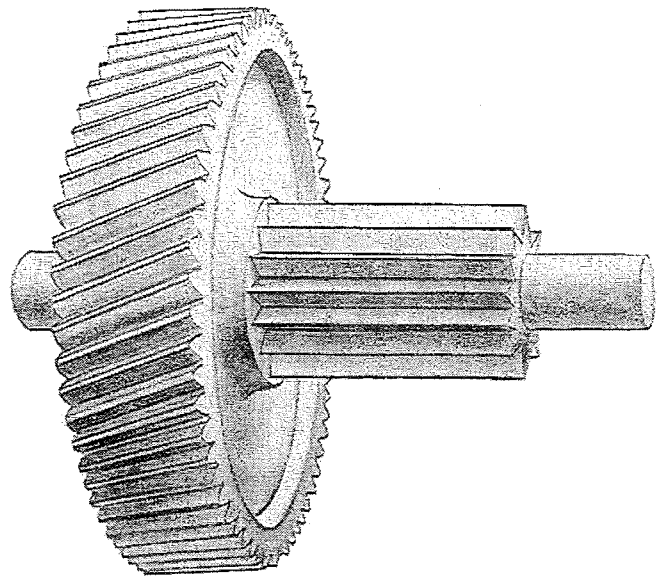

32 N.D.P. HELICAL GEAR AND 32 D.P. PINION:
MOLYBDENUM DISULPHIDE - FILLED NYLON

Referring to Table 1 it would appear that the gear could be molded of a number of plastics. But now the physical and chemical properties of these plastics must be studied in relation to the environment in which the gear is to operate. The strength of the plastics fall off to a greater or lesser degree with increase in temperature; not all plastics are resistant to the action of certain liquids, including some lubricants; there are a few which degrade when exposed for long periods to direct sunlight; some are more dimensionally stable than others; and resistance to wear varies from one plastic to another.

ACCURATE MOLDED PLASTIC GEARS

As will be apparent, the ultimate choice of a plastic demands a close study of the project, preferably with the help of the plastic manufacturer and the molder. The recognized gear molders can be of considerable assistance as they have many case histories on which to draw in making their recommendations. Price, of course, is an important factor in arriving at the final choice. This would appear to be self evident, but it is not always given sufficient consideration.

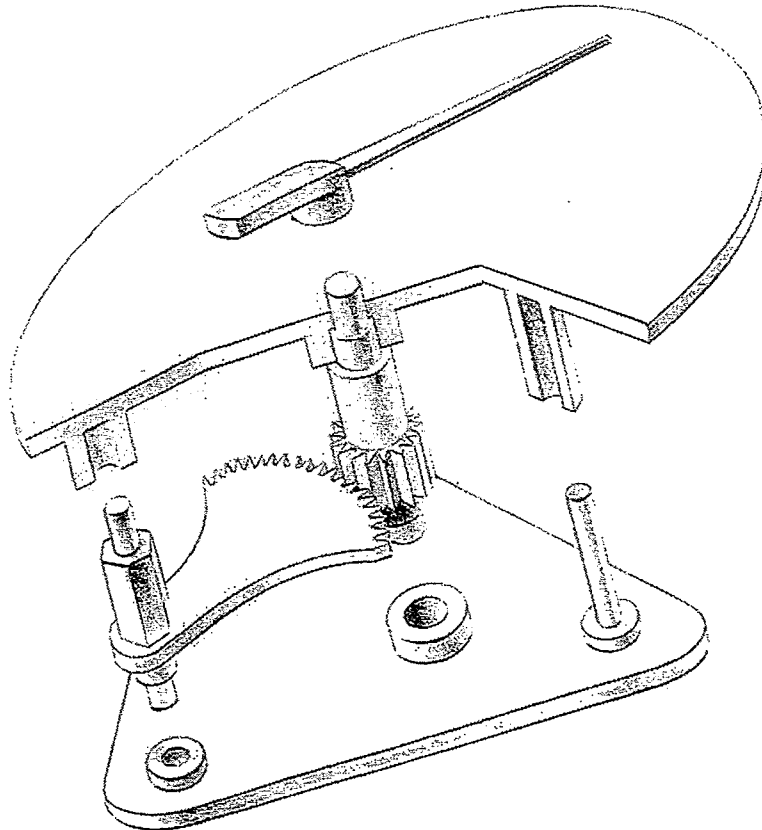

INSTRUMENT ASSEMBLY, 120 D.P. SECTOR
GEAR: ACETAL, 120 D.P. PINION: NYLON,
HOUSING: POLYCARBONATE.

WHAT PROPERTIES PECULIAR TO PLASTICS REQUIRE CONSIDERATION IN THE DESIGN OF A PLASTIC GEAR?

Nothing has as yet been uncovered about the behavior of plastics in gearing that would indicate any necessity to depart from the principles of design established for gears of other materials. But the physical characteristics of plastics make it essential to adhere to these principles more rigidly than would necessarily be the case in designing gears to be machined of the metals. The design of all plastics gearing should receive the close study normally reserved for metal gears in critical applications.

The coefficients of linear thermal expansion of plastics, particularly the unfilled varieties, are considerably greater than those of the metals. Whereas there are only isolated instances when it is necessary to take into consideration the expansion of metal gears with increase in temperature, it is necessary to calculate the amount by which plastic gears will expand at the highest temperature to which they will be subjected, and to provide sufficient backlash to prevent binding. Some plastics are hygroscopic. Gears of these materials will expand to some degree if exposed to moisture. This rarely poses a problem, but additional backlash should be allowed if the mechanism of which the gears are part may remain unused for long periods in a damp atmosphere.

The teeth of heavily loaded metal gears in critical drives are given a degree of tip relief to lessen the ill effects of deflection, and have full fillet root radii to reduce fatigue stresses. These modifications should be specified for the teeth of all plastic gears.

In designing a pair of gears, use is frequently made of what is known as the long-short addendum system. If the pinion has a small number of teeth, these teeth may be undercut. Undercutting can be eliminated by increasing the addendum of the pinion teeth and decreasing that of the gear teeth. Undercutting weakens teeth, causes undue wear and may obviate continuity of action. Applying the long-short addendum system in designing gears also decreases the amount of approach action that occurs as the teeth of mating gears are going through the initial stage of their contact. Approach action is more taxing in terms of wear than the recess action that takes place during the later stage of tooth contact. The elimination of undercutting and the reduction of approach action are particularly beneficial when the gears are of plastic.

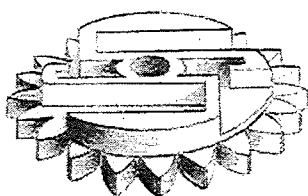

36 D.P. PINION AND PAWL
POCKETS: ACETAL

The advantages of the molding process as a means of fashioning gears must also be realized. The designer is freed from many of the limitations imposed by the necessity to think in terms of what is possible in using machine tools to make the blanks, and standard hobs and cutters, in generators and shapers, to form the teeth. Not only can expensive machining and assembly operations be eliminated by designing the gear to be integral with other parts in the one molding, but desirable modifications to the standard tooth can be specified without increasing the price of the gear, and at little or no additional cost for the molding die.

A number of designers have been quick to recognize and exploit these advantages. There are now being molded for use in instrument mechanisms gears of such complexity that their fabrication in metal would not be economically feasible. The various illustrations throughout this section indicate only some of the possibilities. In applying the molding process to the production of gears there is today little that can be ruled out as being impossible or impracticable. Consultation with a molding die maker before designs are made final may well result in considerable cost savings in the overall project by combining several features in a single molding.

HOW SHOULD PLASTIC GEARS BE DESIGNED? HOW SHOULD THEIR SPECIFICATIONS BE WRITTEN?

If the first production samples of a machined gear prove to be for any reason unsatisfactory, effecting the necessary changes usually involves nothing more than a few adjustments to the settings of the machine used to cut the teeth. The first samples of a molded plastic gear are obtained only after there has been built a molding die on which has been expended many man-hours of highly skilled labor. Changes are both time-consuming and costly. It is essential, therefore, that the final design of a plastic gear be the result of close study and that the data appearing on the drawing be exact, and so specified that there can be no possibility of misinterpretation.

How plastic gears are designed is fully discussed elsewhere, as is also the writing of specifications, but because the data on gear drawings are so often vague and conflicting, it is felt that some comments on the subject may be helpful. There has been published by the American Gear Manufacturers Association, Standards Department, 1500 King Street, Suite 201, Alexandria, Va. 22314, a series of standards relating to the procedures to be followed in writing gear specifications and inspecting finished gears. These standards are universally accepted and should be rigidly adhered to in specifying plastics gearing. The following is a list of the relevant standards:

- 1012-F90 Gear Nomenclature, Definitions of Terms with Symbols.
- 910-C90 Information Sheet – Format for Fine-Pitch Gear Specification Data.
- 1003-G93 Tooth Proportions for Fine-Pitch Spur and Helical Gears.
- 2000-A88 Gear Classification and Inspection Handbook.
- 1006-A97 Tooth Proportions for Plastic Gears.

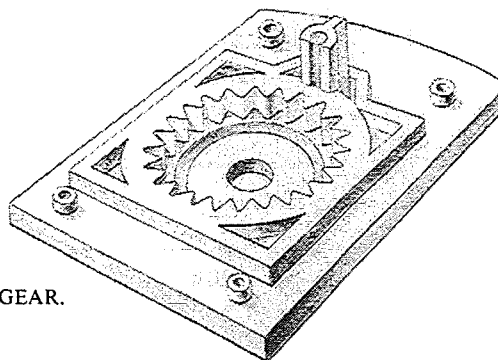

COVER PLATE WITH 36 D.P. INTERNAL GEAR.

Other publications that will be found useful to the gear designer are:

Buckingham, Earle: "Manual of Gear Design"
Sections 1,2 and 3
Buckingham Assoc., Inc.
Parker Hill Road
Springfield, Vt. 05156

Dennis P. Townsend, Editor:
"Dudley's Gear Handbook"
Second Edition
McGraw-Hill, Inc.
New York, NY

Van Keuren Co.: "Van Keuren Precision Measuring
Tools Catalog and Handbook"
The Van Keuren Company
Watertown 72, Mass.

ACCURATE MOLDED PLASTIC GEARS

For ease of reference, the tooth proportions of standard spur and helical gears are illustrated and tabulated in Fig. 1.

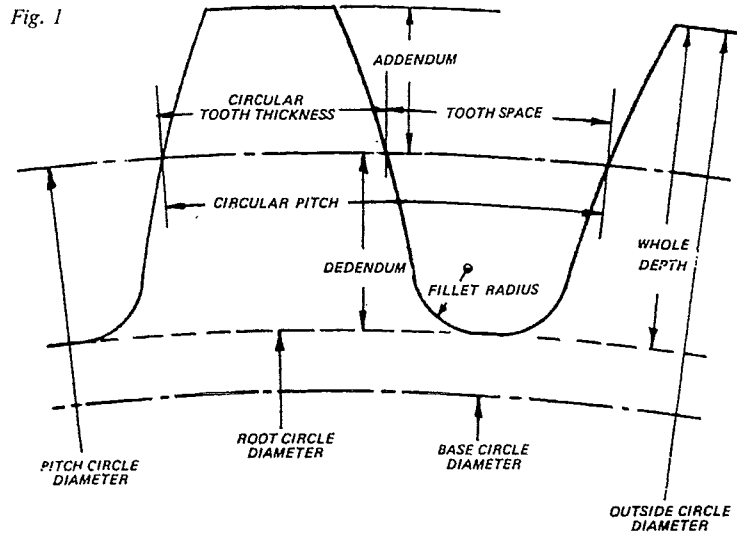

	Coarse-Pitch 19.99 and Coarser	Fine-Pitch 20.00 and Finer
Addendum	$\frac{1.000}{P}$	$\frac{1.000}{P}$
Dedendum	$\frac{1.250}{P}$	$\frac{1.20}{P} + .002$
Whole Depth	$\frac{2.250}{P}$	$\frac{2.20}{P} + .002$
Circular Tooth Thickness	$\frac{\pi}{2P}$	$\frac{\pi}{2P}$

P = Diametral Pitch

Of all the data to go on the drawing of a gear, none is of greater importance than that defining the tooth thickness required. Since it would appear that there are differences of opinion about just how tooth thickness should be specified, and how a gear should be inspected to insure that the specification has been met, some comments may be in order.

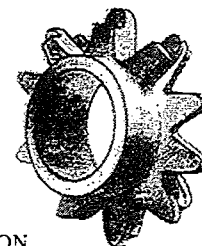

ACCURATE MOLDED PLASTIC GEARS

SECTION A
CHAPTER 4
PAGE 3

The circular pitch of a gear is the circumference of the standard pitch circle divided by the number of teeth, and the standard circular tooth thickness is half the circular pitch. If two mating gears have standard tooth thicknesses and are brought into close mesh, the distance between their centers will be half the sum of their standard pitch diameters. But two gears having standard tooth thicknesses could operate at the standard center distance only if both gears were perfect. Any errors in the gears would cause them to bind at some point in their rotation, the one with the other.

The errors present in a gear are:

- Runout
- Lateral runout (wobble)
- Pitch error
- Profile error

The pitch error plus the profile error add up to what is called the tooth-to-tooth composite error, and this plus the total runout is known as the total composite error. By rotating a gear in close mesh with a master gear of known accuracy in a variable center distance fixture, the tooth-to-tooth and total composite errors can be determined by noting the radial displacements. If the radial displacements were to be charted, the result would appear as shown in Fig. 2.

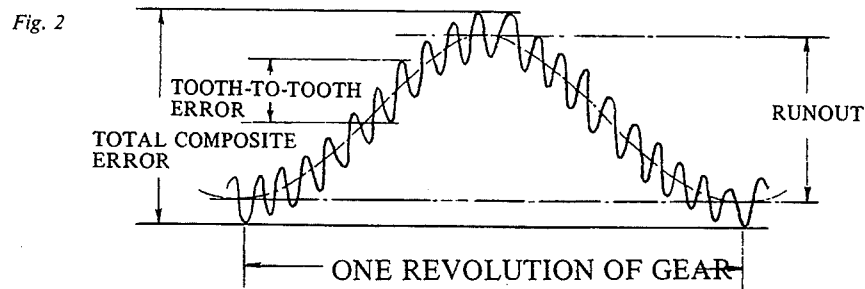

There are center distance measuring instruments available of various types. The simpler models are equipped with a dial indicator and require that the operator note the radial displacements as the gear is rotated manually through 360° in close mesh with the master gear. The more sophisticated models trace the radial displacements, through an electronic device, on a moving chart. Fig. 3 shows one of the simpler models.

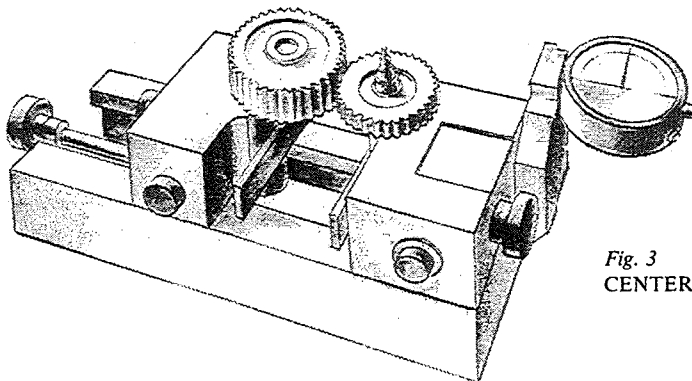
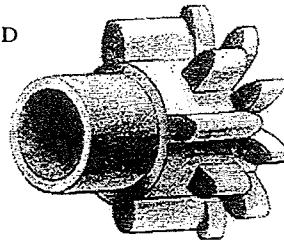

Fig. 3
CENTER DISTANCE MEASURING INSTRUMENT.

ACCURATE MOLDED PLASTIC GEARS

A system has been developed by the American Gear Manufacturers Association whereby gears are classified by number in accordance with their accuracy in terms of the maximum tooth-to-tooth and total composite tolerances allowed them. This number is called the AGMA Quality Number. The AGMA Quality Numbers and the corresponding maximum tolerances, by diametral pitch and pitch diameter, are listed in the American Gear Manufacturers Association "Gear Handbook, 2000-A88."

36 D.P. COMPOUND
PINION: ACETAL



If a gear had assigned to it a Quality Number such that the maximum tooth-to-tooth and total composite tolerances were .0019 and .0027 respectively, and if the errors in the gear were at the maximums allowed by these tolerances, the chart from the center distance measuring instrument would appear as shown in Fig. 4.

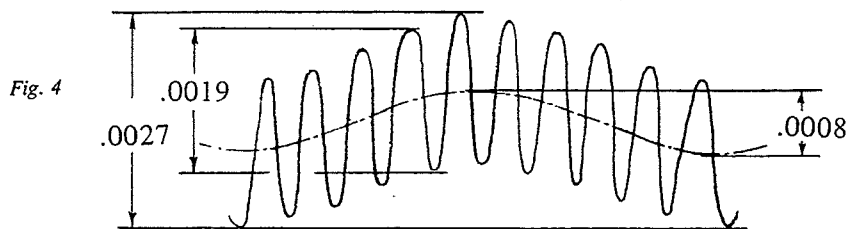

To allow for the errors in two mating gears, either the operating center distance must be made greater than the calculated close mesh center distance by an amount equal to the sum of half the total composite tolerances, or the tooth thicknesses must be thinned by an equivalent amount. AGMA Quality Numbers must be chosen for a pair of mating gears at an early stage in the design procedure, and the finished gears must be inspected by being run in close mesh with a master gear in a center distance measuring instrument to insure that the errors do not exceed the maximums allowed by the tolerances.

Included in the data on the drawing of a gear is the "gear testing radius". The gear testing radius is the center distance between the gear and a master gear, less half the pitch diameter of the master. It has maximum and minimum values corresponding to the maximum and minimum values of the calculated circular tooth thickness, and the maximum total composite tolerance. Just how the testing radius is established can best be explained by working through an example.

A spur gear has 80 teeth, a diametral pitch of 32, and a pressure angle of 20° . The gear is required to have an accuracy corresponding to AGMA Quality Number Q7. The standard pitch diameter is 2.500. From the AGMA "Gear Handbook" it is found that the maximum total composite tolerance is .0036. The gear has a calculated circular tooth thickness of .0460 max. .0445 min. Calculate the testing radius. Assume that the gear will be inspected by being run in close mesh with a master gear having 64 teeth, a pitch diameter of 2.0000, and a circular tooth thickness of .0491.

ACCURATE MOLDED PLASTIC GEARS

SECTION A
CHAPTER 4
PAGE 5

Calculate the close mesh center distance between gear and master when the circular tooth thickness is at the maximum of .0460 and when it is at the minimum of 0.445.

$$C = \frac{(N_1 + N_2) \times \cos \phi}{2 \times P \times \cos \phi_1}$$

where C = close mesh center distance

N_1 = number of teeth in gear

N_2 = number of teeth in master

P = diametral pitch

ϕ = pressure angle

ϕ_1 = angle whose involute is $\frac{P(t_1 + t_2) - \pi}{N_1 + N_2} + \text{inv } \phi$

where t_1 = circular tooth thickness of gear

t_2 = circular tooth thickness of master

π = 3.1415926

$$N_1 = 80 \quad N_2 = 64 \quad \phi = 20^\circ \quad P = 32 \quad t_1 = .0460 \text{ max. } .0445 \text{ min.} \quad t_2 = .0491$$

$$\text{inv } \phi_1 = \frac{32(.0460 + .0491) - 3.1415926}{80 + 64} + .01490438 = .01422110$$

$$\phi_1 = 19.699611^\circ$$

$$\cos \phi_1 = .94147283$$

$$C = \frac{(80 + 64) \times .93969262}{2 \times 32 \times .94147283} = 2.2457$$

and

$$\text{inv } \phi_1 = \frac{32(.0445 + .0491) - 3.1415926}{80 + 64} + .01490438 = .01388776$$

$$\phi_1 = 19.549391^\circ$$

$$\cos \phi_1 = .94235339$$

$$C = \frac{(80 + 64) \times .93969262}{2 \times 32 \times .94235339} = 2.2436$$

Close mesh center distance = 2.2457 max. 2.2436 min.

To complete the calculation, half the total composite tolerance is added to the maximum close mesh center distance, half is subtracted from the minimum, and from both results is subtracted half the pitch diameter of the master gear.

$$2.2457 + \frac{.0036}{2} - \frac{2.0000}{2} = 1.2475$$

$$2.2436 - \frac{.0036}{2} - \frac{2.0000}{2} = 1.2418$$

Testing radius = 1.2475 max. 1.2418 min.

ACCURATE MOLDED PLASTIC GEARS

If the charts of two samples from the production run of a gear were to be superimposed, the one on the other, they might appear as shown in Fig. 5.

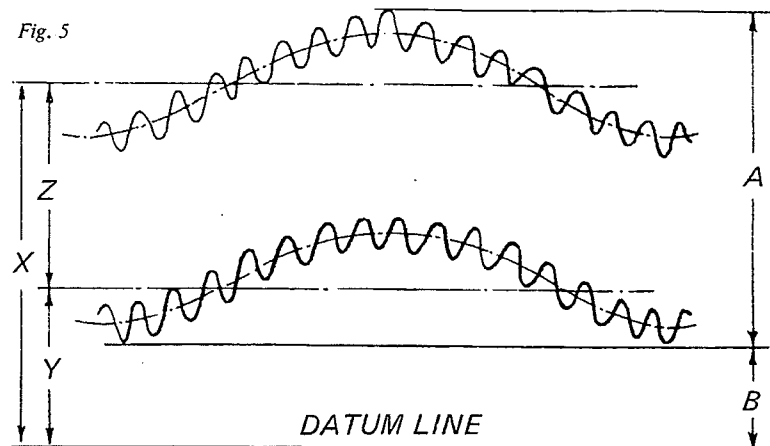

"A" is the difference between the maximum test radius of one sample and the minimum test radius of the other. The tooth thickness of one sample differs from that of the other by an amount equivalent to a radial displacement of "Z". If it so happens that the total composite error in each sample is less than what is allowed by the tolerance, then "Z" could be greater than the difference between the maximum and minimum calculated tooth thicknesses as specified on the drawing. Yet both samples would be acceptable if their testing radii checked within the maximum and minimum specified values. It is for this reason that the tooth thickness of a gear appears on the drawing as a "basic specification" rather than being included in the "manufacturing and inspection" data, and why it is referred to as the "calculated" circular tooth thickness. It is also the reason why the measurement over pins has a proviso to the effect that this measurement is to be used "for set-up only".

Shown in Figs. 7-1 and 8-3 of "A System for Involute Spur and Helical Gears Molded of the Plastics" are the data that should appear on the drawings of spur and helical gears, in formats recommended by the American Gear Manufacturers Association. Having chosen the number of teeth; the tooth form; the helix angle, if applicable; the AGMA Quality Number; and having determined the tooth thickness; the remaining data are arrived at by mathematical computation: only the tolerance to be given to the outside diameter is a designer's choice.

Specifying the tooth thickness and accuracy of a plastic gear in terms of a testing radius precludes any possibility of misinterpretations and makes inspection a simple and quick operation. If the gear checks within the maximum and minimum values specified for the testing radius, and satisfies the total composite and tooth-to-tooth maximum tolerances, it must, of necessity, be correct in all other respects.

Because bevel gears, hypoid gears and worm gears are commonly manufactured as mating pairs, designing and specifying plastic molded gears in these categories present problems not encountered with spur and helical gears. This is particularly true if the pinion or worm is to be made of metal as is often the case. Then the project requires close co-operation between the molding die maker and the manufacturer of the metal part. For these reasons the authors suggest that the designer should proceed with the preliminary work in accordance with the information contained in the relevant American Gear Manufacturers Association standards and then consult with the molder, the molding die maker and, where applicable, the manufacturer of the metal pinion or worm before completing the design.

**HOW ACCURATE ARE MOLDED PLASTIC GEARS?
WHAT AFFECT DOES MOLD SHRINKAGE HAVE ON ACCURACY?**

It has frequently been said that molded gears are not as accurate as machined gears. This is a meaningless statement. A molded gear held to the tolerance of AGMA Quality Number Q8 cannot be other than just as accurate as a machined gear of the same quality number. It is true that gears have not yet been molded to the highest precision obtainable by machining, but the number of gears requiring such precision represents only a very small percentage of all the gears made. Furthermore, accuracy is improving with every gear molded. Fine-pitch instrument gears are now being molded to tolerances that would have been considered impossible of achievement in the recent past. As an example, a four cavity molding die for a fine pitch spur gear in acetal produced gears that, on first sampling, were within the tolerances of AGMA Quality No. Q12. They had a tooth-to-tooth error of .0003, or less, and a total composite error of .0005 or less.

It has also been stated that molded plastic gears need not be as accurate as metal gears. This idea is based upon the contention that, because of the yielding nature of plastic, runout and tooth-to-tooth errors do not have the same ill effects. This is quite wrong. Plastic gear teeth that are flexing to an excessive degree because of inaccuracies will fail through fatigue and wear much earlier than accurate teeth.

All plastics shrink in changing from the liquid to the solid state, and as they cool down to room temperature. As a consequence, all mold cavities must be made larger than the parts molded in them. For example, if a molded gear is to have an outside diameter of 1.200 ins. and the plastic has a mold shrinkage of .025 ins. per ins. the outside diameter of the cavity will require to be 1.230 ins.

In making a gear cavity, however, it is not sufficient to take the same generating hob that would be used to cut the teeth in the gear if it were to be machined, and with that hob cut an oversized gear which, in turn, would be used to form the cavity. This is a common mistake that results in a molded gear with a serious profile error. It would have a tooth-to-tooth error larger than anything acceptable.

Fig. 6 is an enlargement of a 32 D.P., 20° P.A., gear tooth and, superimposed upon it the profile of an over-size gear tooth cut with a standard 32 D.P., 20° P.A. hob.

Fig. 7 again shows the standard gear tooth and this time superimposed upon it, the profile of the molded tooth (after shrinkage) that would be obtained from the oversize cavity.

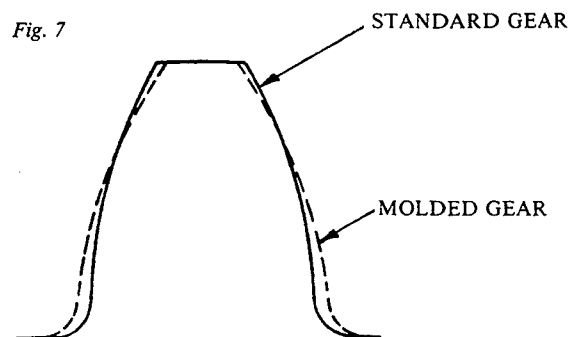
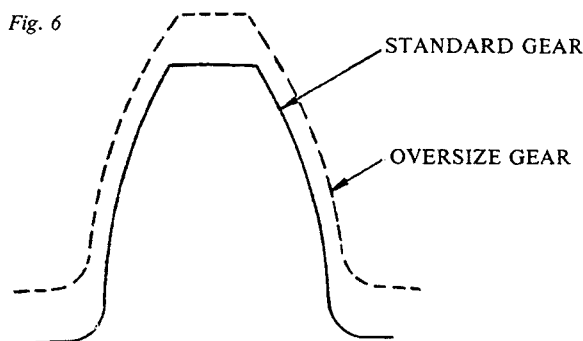

It will be noted that the tooth of the molded gear departs considerably from standard. It is thicker at the root and thin at the tip: it has a pressure angle much in excess of 20°.

ACCURATE MOLDED PLASTIC GEARS

The amount of pressure angle error can be calculated from:

$$\cos \phi_2 = \frac{D \cos \phi_1}{D(1 + S)}$$

where:

D = Pitch circle diameter

ϕ_1 = Pressure angle of hob

ϕ_2 = Pressure angle of molded gear

S = Shrinkage

If, for example, the pitch circle diameter is 1.000 ins., the pressure angle of the hob is 20° and the shrinkage .025 ins. per in., the pressure angle of the molded gear would be:

$$\cos \phi_2 = \frac{1.000 \times .93969262}{1.000 \times 1.025}$$

$$= .91677329$$

$$\phi_2 = 23^\circ 32' 28''$$

This amount of error would result in binding, rapid wear and general mal-functioning.

It will be readily apparent that the teeth in the cavity must be carefully compensated for shrinkage so that, when the molded gear solidifies and becomes stable, the teeth will have the correct profile. This design work is further complicated in the case of a helical gear, as the axial shrinkage is usually quite different from that obtaining across the diameter. Compensating correctly for shrinkage in a gear requires of the mold designer a thorough understanding of gear geometry plus considerable experience in the shrinkage behavior of all types and grades of plastics.

The importance of correctly compensating for shrinkage cannot be over-emphasized. If reference is again made to Fig. 4 it will be seen that this gear can have a total composite error of .0027 and a tooth-to-tooth error of .0019. If the tooth-to-tooth error is up to the maximum, the runout must be held to .0008 ins. T.I.R. But if the tooth-to-tooth error is reduced to .0005 — an amount quite possible of achievement if the cavity is correctly designed and accurately made — it will be seen that the runout can go as high as .0022 ins. T.I.R. Since it is more difficult to control runout than tooth-to-tooth error, as will be discussed in Chapter 7, it is of importance that the profile of a plastic molded gear be as accurate as possible — several degrees more accurate than a comparable machined metal gear.

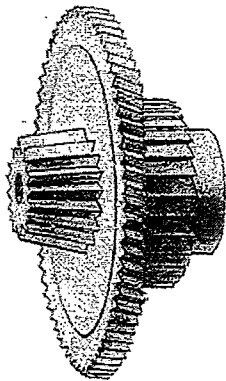

28 D.P. BEVEL PINION, 64 N.D.P. HELICAL GEAR AND
RATCHET: MOLYBDENUM DISULPHIDE - FILLED NYLON

Shrinkage need have no effect on accuracy other than the very minor variations in shrinkage that occur during the course of a production run, and are allowed for in the tolerances given to the molded gear. These minor variations are due to such factors as slight deviations from standard of the molecular weight of the plastic throughout a batch and changes in operating temperature, but a good gear molder can control these variations within very close limits and so hold all the gears in a lot to print tolerances.

It is not an uncommon practice for designers to specify close tolerances for the outside diameters of plastic gears and leave everything else wide open. This is probably done in the mistaken belief that the outside diameter of a molded gear is a measure of overall accuracy, and because this is the easiest dimension to measure. In fact, all that this close outside diameter tolerance insures is that all the errors present in a lot of molded gears will be of the same magnitude from piece to piece. Except in very rare instances, the outside diameter of a gear is, within limits, a matter of no consequence. If it is specified that the tooth thickness of a molded gear is to be held to $+.000 - .001$, then the outside diameter must, of necessity, be permitted to vary within a tolerance band of at least $.0027$ in the case of 20° pressure angle gears and $.0039$ in the case of $14\frac{1}{2}^\circ$ pressure angle gears. For gears given more tooth thickness tolerance, the outside diameter tolerance bands would be greater in the same proportion.

To specify close tolerances for the outside diameter of a molded gear except in the rare cases where the outside diameter is functional — as in pump gears, for instance — can make for unnecessarily high tooling costs and piece prices without in any way guaranteeing that the gears will be accurate in other respects. It cannot be emphasized strongly enough, or often enough, that the accuracy of plastic gears should be specified in terms of AGMA Quality Numbers and should be inspected by the center distance measuring method. No other procedure that is at all practical will insure that the gears will have the desired accuracy.

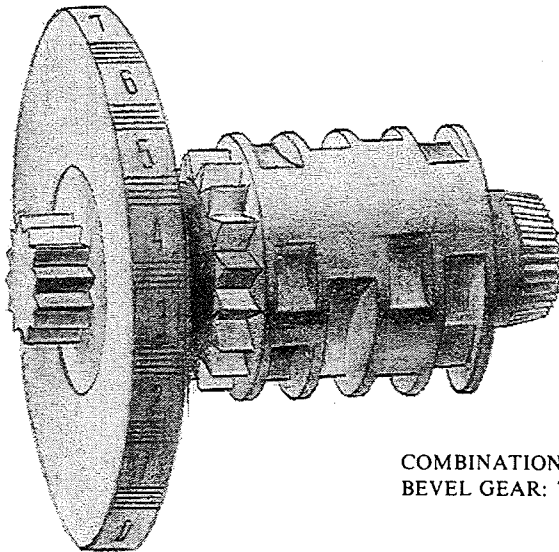

COMBINATION PINION, THUMB WHEEL, RATCHET, CAMS AND BEVEL GEAR: TFE AND GLASS-FILLED POLYCARBONATE.

WHO ARE THE GEAR MOLDERS?

The selection of a molder with whom to place an order for gears should be given careful consideration. Many a purchaser of molded plastic gears has gone through the frustrating experience of waiting weeks for production samples only to find these samples quite unacceptable. There have followed more weeks of waiting while the molder attempts to make corrections, often without much success. The purchaser is then faced with the alternative either to accept poor quality gears, against his better judgment, or to find another molder, with no assurance of any better results.

While it is true that, given a correctly designed and accurately made molding die, any competent molder can produce gears, there are few molding concerns that can be classified as gear manufacturers. A gear molder, however, can be distinguished from a molder who will mold gears; his experience in molding a wide range of gears will qualify him to advise on product design and the selection of materials; he has the molding presses most suitable for gear molding; and he has the inspection equipment necessary to maintain proper quality control.

36 D.P. DOUBLE PINION AND SHROUD: NYLON

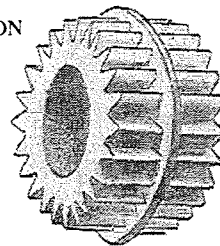

The experienced gear molder will not accept an order if he is unsure of meeting print specifications. In such an event, a meeting of the purchaser's engineers and the molder and his molding die maker will usually produce acceptable modifications that will insure the gear being molded within tolerance. In fact, such a meeting is desirable whether or not any problems are anticipated. A full discussion of a molded gear project by the three parties directly concerned will have the end result of making certain that the gear will be right for the application under review, that the data will be correctly interpreted, and that the method of inspection to be followed is agreed upon and fully understood by the molder and his customer's inspection department.

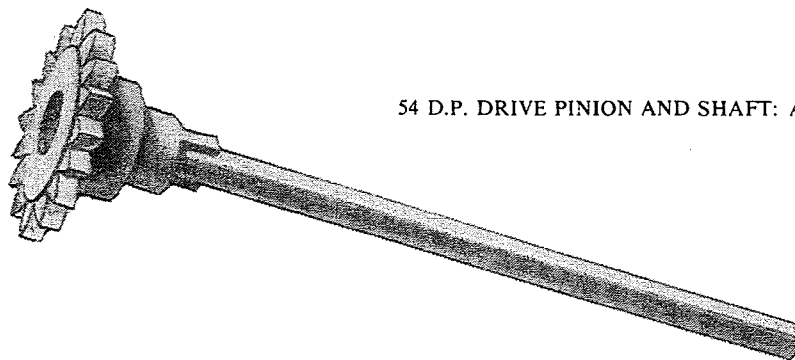

54 D.P. DRIVE PINION AND SHAFT: ACETAL

One yard-stick by which to measure the capabilities of a gear molder is inspection equipment. A molding company that does not have the necessary equipment with which to check gears to insure that they are within the specified tolerances is unlikely to prove a satisfactory vendor.

A gear molder does not need to be a gear engineer. He must, of course, understand how to interpret gear data well enough to know what is required in molding. The knowledge of gearing, and the ability to translate that knowledge into accurate gear molding dies with correct cavities, rests with the gear molding die maker.

HOW ARE ACCURATE GEAR MOLDING DIES MADE?

A molded gear, of course, can be no more accurate than the molding die which produces it. Subtract the tolerances required for molding from the accuracy of the die and the result is the accuracy that can be expected in the gear.

The first requirement, as pointed out in chapter 6, is a complete understanding between the gear user, the molder and the molding die maker. This is the only way to insure that realistic tolerances are specified, that the product design is adequate for its purpose and that it is suitable for molding, that there is a clearly defined inspection procedure, and that the die maker understands all of this so that he can design and construct a molding die compatible to the requirements.

Basic considerations for gear molding dies are the same as for any accurate product. Molded gears being usually small in relation to the size of average moldings, lend themselves admirably to being molded in the small high speed automatic molding presses developed in recent years. This allows for compact dies with a limited number of cavities.

There are several advantages to this size range of molding die work. The most important advantage is that the construction of completely hardened or case hardened die frames is economically feasible. With the considerable increase in frame strength and the limited press clamping tonnages required for their size, these frames are considerably better able to withstand the abuses of the molding process and can maintain their accuracy throughout extended useful life. Of course, this assumes that the accuracy will have been built in in the first place. With adequate jig grinding equipment this can be readily accomplished. With true alignment of cavity bores, guide pin bores, ejector pin bores, tolerances can be held much closer, enabling minimum running fits to assure flash free moldings and minimum wear. The elimination of wear bushings allowed by hardened steel surfaces in the bores removes the additional errors resulting from less than perfect concentricity of these items. The compact arrangement of cavities limits cavity misalignment because of uneven thermal expansion of the die halves that can be caused by uneven temperatures in these halves.

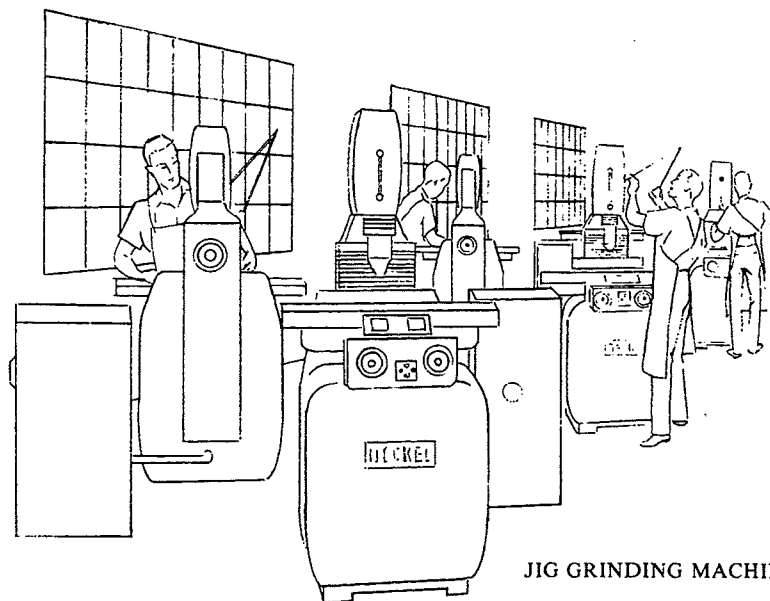

JIG GRINDING MACHINES

ACCURATE MOLDED PLASTIC GEARS

Other basic considerations are also valid. There must be adequate channeling for accurate control of die temperatures. There must be properly designed and sized runner and gating systems made as accurately as the cavities themselves to obtain the truest flow of plastic material to all sections of all the cavities at as even a pressure as is possible. There must be adequate venting in the proper places to allow air to be readily displaced by the flow of plastic again to insure even flow of the melt. There must be ample ejection systems to insure minimum distortion of the product on its ejection from the die. There must be adequate interlocks between the die halves to remove the misalignment of running fits provided in the guide system. These features must not only be designed in by competent design engineers, but this design must be faithfully followed by experienced die makers with precise equipment and ample inspection devices. A schematic cross section of such a gear molding die is illustrated in Fig. 8.

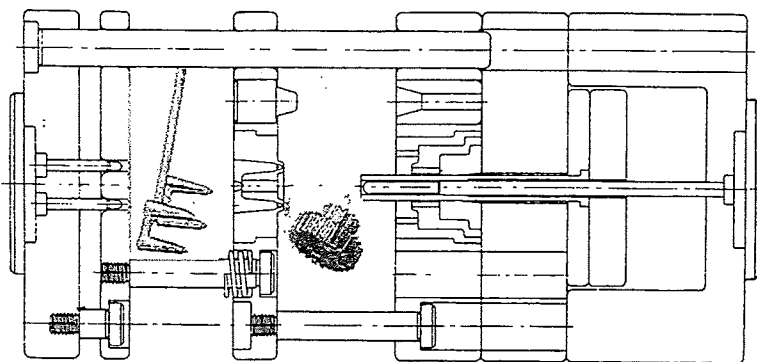

Fig. 8 DIE OPEN

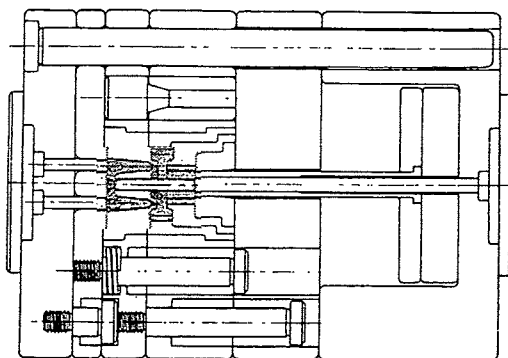

Fig. 8 DIE CLOSED

Beyond basic considerations, however, there are specific problems in gear molding. These can be broken down into the basic essentials of the gear itself. These are tooth-to-tooth error and total composite error. Curiously enough, tooth-to-tooth error, as will be explained later, is not the problem that total composite error is to the molding die maker.

Remembering that total composite error is the sum of tooth-to-tooth error and runout, the problem is simply runout. Starting with the molded gear bore which must be accurate in size and is usually longer than its diameter to be a proper mounting for the gear, creates the first problem. The core pin which molds such a bore must be anchored in both sides of the die, first to insure that any incipient flash will not encroach upon the tolerance of the bore and second to be rigid enough to resist molding pressures. While this pin is closely fitted into the moving half of the die it must be allowed a running fit into the stationary half. The closest of running fits will allow the possibility of $.0001/.0002$ of siding to take place. If sleeve ejection is required around this core-pin, the solid anchor is lost and an additional running fit will allow an additional $.0001/.0002$ of potential siding plus whatever eccentricity there is between the inside and outside diameter of the sleeve. Add to these the probability that the gear cavities themselves are a series of concentric rings, especially in cluster gearing, and it becomes apparent that almost perfection in die making still leaves potentials for runout error. Add to that the molding problem that this gear bore creates by eliminating the most desirable gating position in the true center of the gear. This insures that there must be some unevenness of plastic flow, regardless of how many gates are used, that will result in something less than a perfectly round gear. Therefore, more runout. The magnitude of runout errors is the limiting factor in the accuracy of molding gears of today.

Tooth-to-tooth error, the shoal on which many a well-intentioned but uninformed molding die maker has foundered, can be virtually eliminated. At the very least, it can be held well within the tolerances of most plastic gear applications of today. Therefore, the widely held belief that an accurate gear molding die is obtained only after a number of trial cavities have been made is simply not valid. Competent gear molders are able to predict molding shrinkage within close limits, especially with the filled plastics so often specified. Competent gear molding die makers are able to translate this information into correctly compensated gear cavity dimensions, and then to hold these dimensions in the manufacturing process. The days of "cut and try" are over.

The procedure starts with the examination of the data specified for the molded gear. Once this is determined to be explicit and non-conflicting, shrinkage allowances can be calculated to arrive at the exact dimensions that the cavity will require. Inspection reference dimensions can also be calculated and projection charts can be produced to insure that these dimensions will be held.

The actual manufacture of accurate gear cavities is usually accomplished by ram electrical discharge machining (EDM); whether the configuration is spur, helical, worm, bevel, or hypoid; whether or not the gear and the cavity design allows for a thru-burn (no bottom to the cavity section allowing the electrode to continue to pass on through) or a stop burn; whether the bottom of the cavity is flat or has configuration such as in a mutilated pinion. This discharge machining is done in previously hardened blanks to surface finishes that are fine enough to act as the final finish of the molding cavity. With no further processing to be done, the integrity of the discharge machined gear teeth remains intact. There is no tooth-to-tooth error introduced after discharge machining.

The possible sources of error for ram EDM are reduced then to the manufacture of the electrode for discharging and the discharge process itself. (The final grinding of the cavity blank introduces no error.) Today's electrical discharge machines, with proper fixturing and control devices, in the hands of highly skilled operators who not only understand their process but who also know what is required in a gear cavity and who know the die making procedures as well, can truly translate the electrode forms into a finished gear tooth form. Even with this skill, however, it is impractical in discharge machining to hold sufficient concentricity of the gear form to the blank itself. Stock is therefore allowed on the discharge blank to allow accurate grinding of the finished cavity to hold as close a concentricity as possible of the gear form to the remainder of the molding die components. This, of course, is to hold the total composite error, or runout, to a minimum.

ACCURATE MOLDED PLASTIC GEARS

The procedure between the design of the gear cavity and ram electrical discharge machining is the design and manufacture of the electrode. It has been shown that none of the other processes introduce any appreciable tooth-to-tooth error. Therefore, if this electrode is accurate, tooth-to-tooth error, as stated, can be held to reasonable minimums.

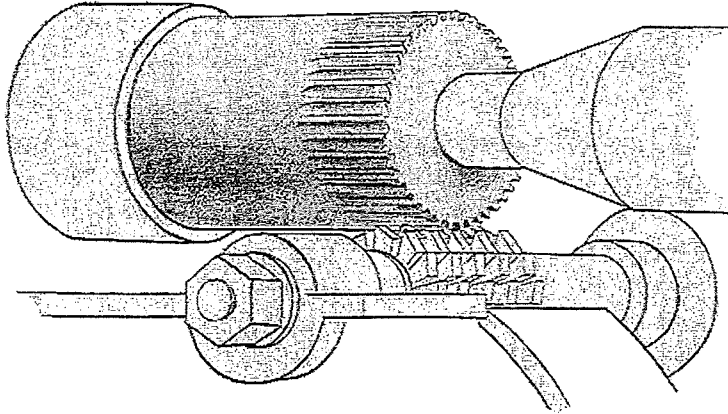

GENERATION OF A GEAR ELECTRODE.

The design of the electrode is identical to the design of the finished gear tooth form blank with one exception. That exception is the spark gap allowance for the discharge machining process. Experienced molding die makers can predict this allowance closely for their particular equipment and methods. The gear molding die maker, knowing that the smaller this gap is, the better control he has in accuracy and surface finish, even though the machining is considerably slower, works to minimum spark gap allowances.

Accurate gear electrodes are generated in a manner similar to the manufacture of gears of the same configuration on similar types of equipment. The difference between the processes is only in the accuracy required. Gear molding die makers, since one electrode may in turn provide the cavity that will produce millions of gears, take the utmost of care in this process to insure that the equipment is in excellent condition and that the operation of it is entrusted to only highly skilled die makers. Since the nature of the generating operation itself is self-cancelling as far as spacing errors in the teeth are concerned, and, because extreme care can be and is taken to assure that the form and size is correct, this final source of error is reduced to acceptable minimums.

Wire electrical discharge machining is an alternate to ram but only for spur gearing and only for those cavity configurations that allow for a thru-burn. Properly done, wire can create cavities with all of the features and be equal in quality to those produced by ram. Unfortunately, there are too many wire software gear design programs in use that improperly develop the trochoid area (root below the involute) and some that only crudely approximate the working involute area of the gears. Software such as this can only lead to gears of less strength, less efficiency, and, in some instances, to interference between mating gears.

The equipment and the skills are available now to manufacture truly accurate gear molding dies. The cost of the extra care required to do so is relatively small in proportion to the cost of ordinary gear molds. This extra cost, when amortized over the production of thousands of gears, is hardly noticeable. It remains only for the purchaser to decide that this is what he wants.